

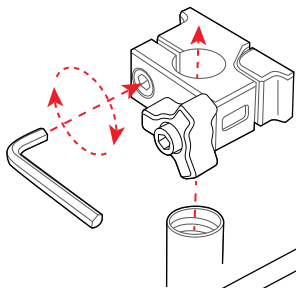

Using your Jumper

- 1** Permanently mount your jumper in place of the Gorilla Plate



- 2** With your camera mounted you can now go from a DSLR Baseplate to a Gorilla Rig

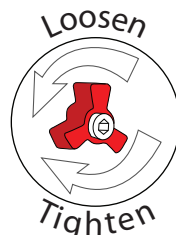
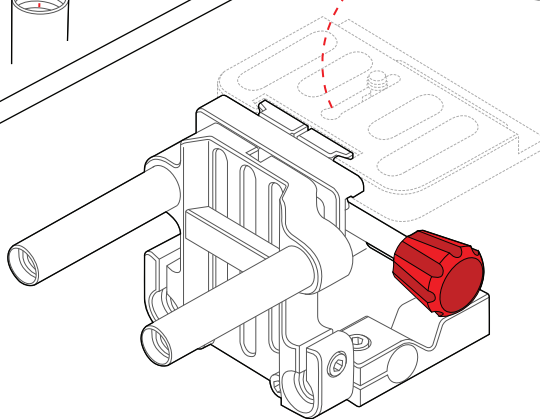
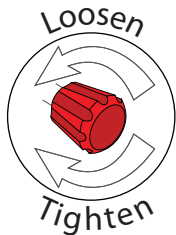
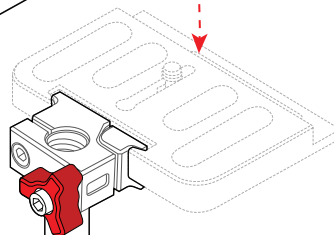
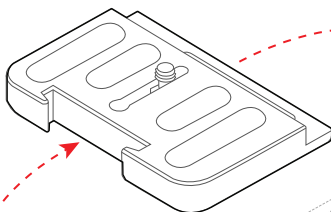

Included Parts:

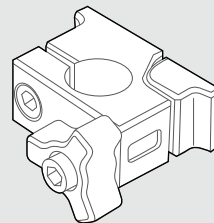

x1 Jumper

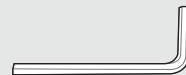

x1 5/32" Allen

